

LOW CEILING Applications <4m

NÍZKY STROP Aplikácia <4m

LEDLUX-SPOT3 type serie is equipped with the combination of HighPower LED and sophisticated lenses. Thanks to the both maximum efficiency and optimal light distribution result in the need for a low number of luminaires for emergency lighting in conformity with relevant standards. It is completely independent of general lighting. Thanks to LEDLUX-SPOT3 design the installation and maintenance is quick and simple. The fixture proves its application flexibility with its range of installation options.

Moderný a nenápadný design vychádzajúci z kvalitných materiálov predurčuje svietidlo LEDLUX-SPOT3 pre núdzové osvetlenie v súlade s relevantnými normami plne nezávislým na hlavnom osvetlení. Svietidlá sú vybavené vyváženou kombináciou HighPower LED a špeciálnej optiky, čo zaručuje maximálnu účinnosť a optimálnu distribúciu svetla. Vďaka tomu je potrebný malý počet núdzových svietidiel pre vašu aplikáciu. LEDLUX-SPOT3 dokazuje svoju aplikačnú flexibilitu vďaka širokej typovej rade s rôznymi inštaláčnymi možnosťami.

Light source	LED 5000K
Installed load	4.6W/5.4VA (maintained M) 2.2W/4.3VA (non-maintained NM) 3.1W/4.4VA (CBS)
Housing colour	RAL9003 White RAL9006 Grey
Application	Escape route lighting Anti-panic lighting



LEDLUX-SPOT3-V-A
(Page No.120)



LEDLUX-SPOT3-P-A
(Page No.126)



LEDLUX-SPOT3-P-A IP65
(Page No.132)



LEDLUX-SPOT3-V-B
(Page No.124)



LEDLUX-SPOT3-P-B
(Page No.130)



LEDLUX-SPOT3-P-B IP65
(Page No.134)

HIGH CEILING Applications >4m

VYSOKÝ STROP Aplikácia >4m

HIGH CEILING application LEDLUX-SPOT2 HCA/HCB type series is equipped with the combination of all 2xHigh-Power LEDs, sophisticated optics and powerful battery. Thanks to all the high light output, maximum efficiency and optimal light distribution result in the need for a low number of luminaires for high ceiling application emergency lighting in conformity with relevant standards. It is completely independent of general lighting. Thanks to LEDLUX-SPOT2 HCA/HCB design the installation and maintenance is quick and simple.

Typová rada LEDLUX-SPOT2 HCA/HCB je určená pre núdzové osvetlenie priestorov s vysokou výškou stropu. Moderný a nenápadný design vychádzajúci z kvalitných materiálov predurčuje svietidlo LEDLUX-SPOT2 pre núdzové osvetlenie v súlade s relevantnými normami plne nezávislým na hlavnom osvetlení. Svietidlá sú vybavené vyváženou kombináciou 2xHighPower LED, špeciálnej optiky a výkonnej batérie, čo zaručuje vysoký svetelný tok, maximálnu účinnosť a optimálnu distribúciu svetla. Vďaka tomu je potrebný malý počet núdzových svietidiel pre vašu aplikáciu. Inštalácia a údržba svietidiel je rýchla a jednoduchá.

Light source	LED 5000K 450lm
Housing colour	RAL9003 White (metal) RAL9006 Grey (metal) Polycarbonate
Application	High Ceiling Escape route lighting High Ceiling Anti-panic lighting



C.LEDLUX-SPOT-P-HCA / MULTILED-SPOT-P-HCA
(Page No.138)



C.LEDLUX-SPOT-P-HCA / MULTILED-SPOT-P-HCA
IP65
(Page No.140)



C.LEDLUX-SPOT-P-HCB / MULTILED-SPOT-P-HCB
(Page No.144)



C.LEDLUX-SPOT-P-HCB / MULTILED-SPOT-P-HCB
IP65
(Page No.146)

NÍZKY STROP Aplikácia <4m

LOW CEILING Applications <4m

LEDLUX-SPOT3-A-V / LEDLUX-SPOT3-A-P

escape routes lighting

LED emergency luminaire for escape route lighting in accordance with EN1838
Maximum luminaire spacing : up to 23,5m>1lx

LED núdzové svietidlo pre osvetlenie únikovej cesty v súlade s EN1838
Maximálny rozstup svietidiel: až 23,5m>1lx

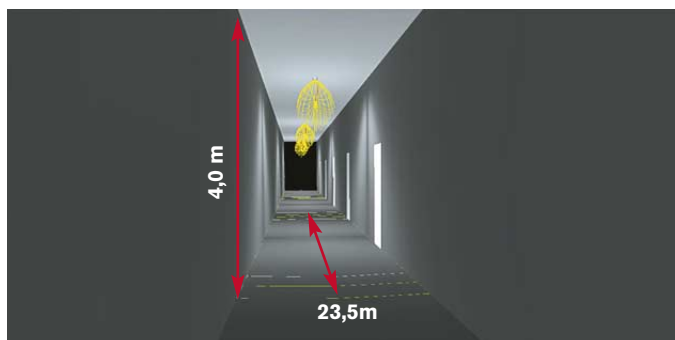
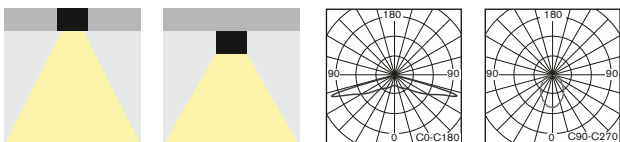

LEDLUX-SPOT3-B-V / LEDLUX-SPOT3-B-P

Anti-panic in open area applications

LED emergency luminaire for anti-panic lighting in accordance with EN1838
Maximum room illumination: up to 80m²>0,5lx

LED núdzové svietidlo pre osvetlenie otvorených priestorov v súlade s EN1838
Maximálna plocha osvetlenia v otvorenom priestore: až 80m²>0,5lx

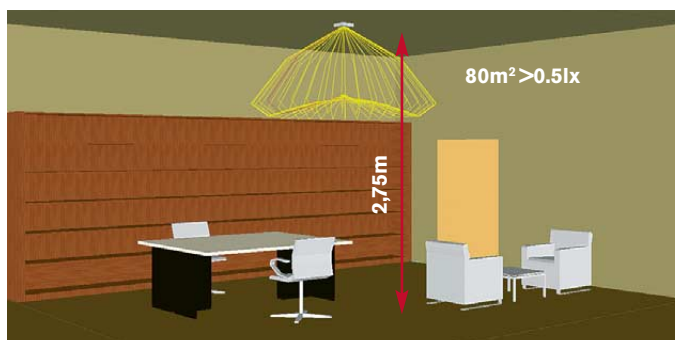
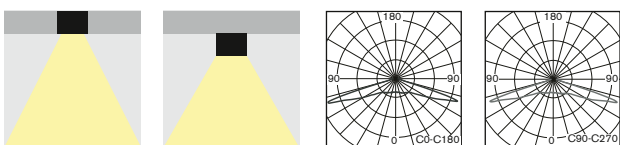

Look up pages No. 190-197 for 1lx Spacing tables
Pozri str.190-197 pre rozmiestnenie svietidiel na dosiahnutie 1lx

VYSOKÝ STROP Aplikácia >4m

HIGH CEILING Applications >4m

LEDLUX-SPOT2-HCA-P

escape routes lighting for **HIGH CEILING** applications

LED emergency luminaire for escape route lighting in accordance with EN1838
Designed for high ceiling corridor application up to 8m mounting height
Maximum luminaire spacing : up to 30m>1lx

LED núdzové svietidlo pre osvetlenie únikovej cesty v súlade s EN1838
Určené pre montáž na strop až do výšky 9m
Maximálny rozstup svietidiel: až 30m>1lx

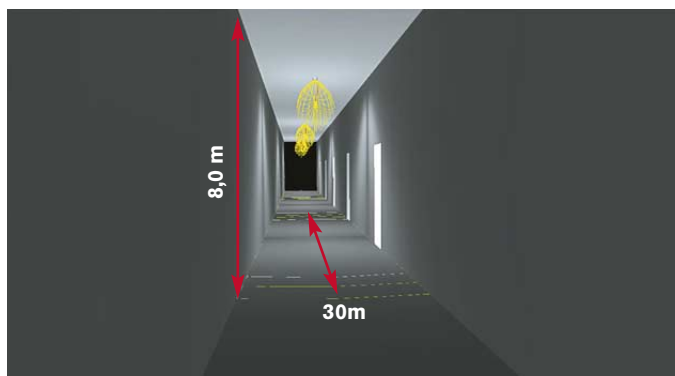
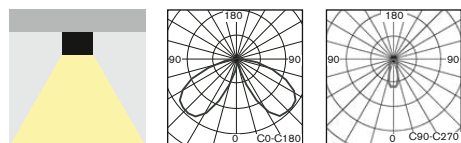

LEDLUX-SPOT2-HCB-P

Anti-panic in **HIGH CEILING** open area applications

LED emergency luminaire for anti-panic lighting in accordance with EN1838
Designed for high ceiling open area application up to 8m mounting height
Maximum room illumination: up to 211m²>0,5lx

LED núdzové svietidlo pre osvetlenie otvorených priestorov v súlade s EN1838
Určené pre montáž na strop až do výšky 8m
Maximálna plocha osvetlenia v otvorenom priestore: až 211m²>0,5lx

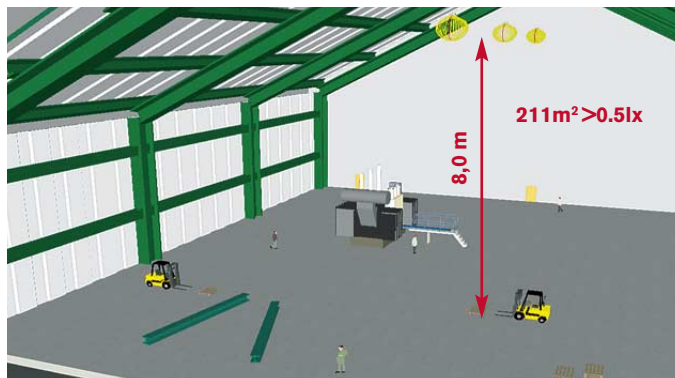
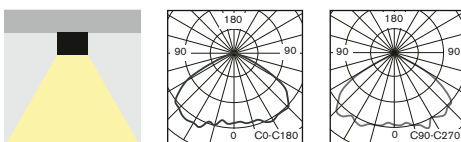

Look up pages No. 190-197 for 1lx Spacing tables
Pozri str.190-197 pre rozmiestnenie svietidiel na dosiahnutie 1lx

RECESSED ESCAPE ROUTE ILLUMINATION LEDLUX-SPOT3-A-V



RAL9003



RAL9006



RAL9005

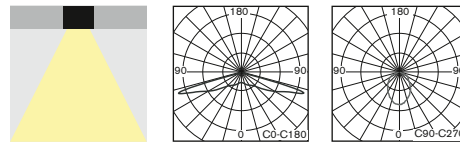

• Small and powerful **recessed LED** non-maintained (NM), maintained (M) or centralised (C) emergency lighting for perfect light distribution **especially** designed for a **corridor applications (escape route illumination to EN1838)**. It is available in all following versions:

- **AUTOTEST** (-AT)
- **DALI**
- **CENTRALTEST** (-ATXL) for **ELMAX LOOK** system (look up also page No.22)
- **CENTRALTEST** (-ATRF) for **ELMAX Wireless** system (look up page No.24)
- **CENTRAL BATTERY** (C.LEDLUX-SPOT3) for **non-addressable CBS**
- Conforming to the requirement of EN60598-2-22, EN1838, EN62034
- Design: plastic body in RAL9006 (grey) or RAL9003 (white) or RAL9005 (black)

• dizajnové, výkonné LED svetidlo pre **netrvalé (NM), trvalé (M)** alebo **centrálne (C)** núdzové osvetlenie pre zapustenú montáž zaručujúce vysokú hladinu svetelného toku špeciálne navrhnuté pre osvetlenie chodieb, aj s funkciami:

- **AUTOTEST** (-AT)
- **DALI**
- **CENTRALTEST** (-ATXL) pre systém ELMAX LOOK (pozri str.22)
- **bezdrôtový CENTRALTEST** (-ATRF) pre ELMAX-Wireless systém (str.24)
- **CENTRAL BATTERY** (C.LEDLUX-SPOT3) pre **neadresovateľné CBS**
- spĺňa požiadavky európskej normy EN 60598-2-22, EN1838, EN62034
- konštrukcia: teleso z plastu vo farbe RAL9006 (šedá) alebo RAL9003 (biela) alebo RAL9005 (čierna)

STANDARD FEATURES

ŠTANDARDNÁ VÝBAVA

- **High efficient HighPower (170lm/W) LONGLIFE LEDs (>100.000h)**
- **NEW Advanced Electronics**
- **LONGLIFE LiFePo4 battery**
- **Special LED lens** for perfect light distribution
- **Installation Mode** (battery protection, for more details look up page No.28)
- **Intelligent battery charging**
- Addressable CENTRALTEST communication module (for ATXL or ATRF)
- LEDs indicating presence of power supply and signaling failures & TEST button
- **vysoko účinné HighPower LED (170lm/W) so životnosťou min.100000h**
- **progressívna elektronická jednotka**
- **LONGLIFE LiFePo4 batéria**
- špeciálna LED optika pre perfektnú distribúciu svetla
- **Inštalčný mód** (ochrana batérie, pozri aj str.28)
- **Inteligentné nabíjanie batérie**
- adresovateľný CENTRALTEST komunikačný modul (len pre ATXL, ATRF verzie)
- signalizácia LED a TEST tlačítko

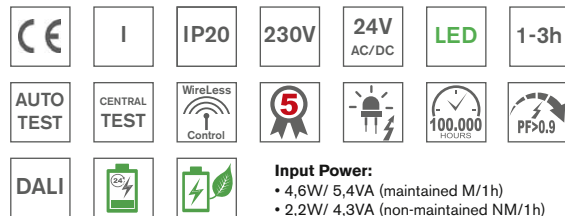

Input Power:

- 4,6W/ 5,4VA (maintained M/1h)
- 2,2W/ 4,3VA (non-maintained NM/1h)
- 3,1W/ 4,4VA (CBS)

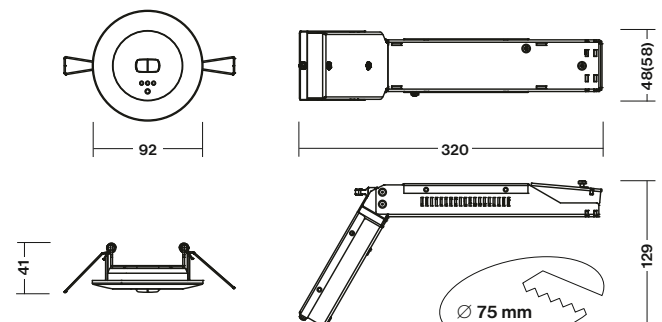

* Dimmensions in the bracket are valid for 3h versions
* rozmery v zátorke platia pre 3h verzie



RECESSED ESCAPE ROUTE ILLUMINATION LEDLUX-SPOT3-A-V

1LX SPACING TABLE / ROZMIESTNENIE PRE 1LX

H (m)	Y1 (m)	Y2 (m)
2,75	8,5	20,5
3,00	8,7	21,5
3,50	9,2	22,5
4,00	8,5	23,5

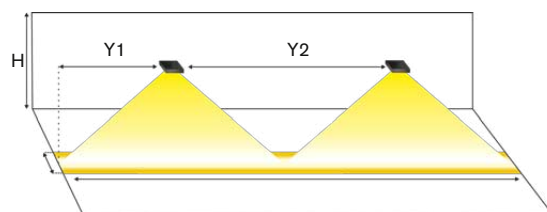

Page No.18

AUTOTEST -AT NM/M

Type	Colour	Light Source	Light Flux / Emergency mode	Battery	Order Code	Weight
LEDLUX-SPOT3-A-V-AT.1h	White / biela	HighPower LED	225 lm / 225 lm	LiFePo4 6,4V/1,0Ah	344-B-001-04-00-01	0,4 kg
LEDLUX-SPOT3-A-V-AT.1h	Grey / šedá	HighPower LED	225 lm / 225 lm	LiFePo4 6,4V/1,0Ah	344-B-001-04-00-02	0,4 kg
LEDLUX-SPOT3-A-V-AT.1h	Black/ čierna	HighPower LED	225 lm / 225 lm	LiFePo4 6,4V/1,0Ah	344-B-001-04-00-03	0,4 kg
LEDLUX-SPOT3-A-V-AT.3h	White / biela	HighPower LED	225 lm / 225 lm	LiFePo4 6,4V/2,0Ah	344-B-002-04-00-01	0,5 kg
LEDLUX-SPOT3-A-V-AT.3h	Grey / šedá	HighPower LED	225 lm / 225 lm	LiFePo4 6,4V/2,0Ah	344-B-002-04-00-02	0,5 kg
LEDLUX-SPOT3-A-V-AT.3h	Black/ čierna	HighPower LED	225 lm / 225 lm	LiFePo4 6,4V/2,0Ah	344-B-002-04-00-03	0,5 kg

DALI SELF-CONTAINED

Type	Colour	Light Source	Light Flux / Emergency	Battery	Order Code	Weight
LEDLUX-SPOT3-A-V-DALI.1h	White / biela	HighPower LED	225 lm / 225 lm	LiFePo4 6,4V/1,0Ah	344-B-005-04-00-01	0,4 kg
LEDLUX-SPOT3-A-V-DALI.1h	Grey / šedá	HighPower LED	225 lm / 225 lm	LiFePo4 6,4V/1,0Ah	344-B-005-04-00-02	0,4 kg
LEDLUX-SPOT3-A-V-DALI.3h	White / biela	HighPower LED	225 lm / 225 lm	LiFePo4 6,4V/2,0Ah	344-B-006-04-00-01	0,5 kg
LEDLUX-SPOT3-A-V-DALI.3h	Grey / šedá	HighPower LED	225 lm / 225 lm	LiFePo4 6,4V/2,0Ah	344-B-006-04-00-02	0,5 kg

Page No.22

CENTRALTEST -ATXL ELMAX-LOOK

Type	Colour	Light Source	Light Flux / Emergency mode	Battery	Order Code	Weight
LEDLUX-SPOT3-A-V-ATXL.1h	White / biela	HighPower LED	225 lm / 225 lm	LiFePo4 6,4V/1,0Ah	344-B-007-04-00-01	0,4 kg
LEDLUX-SPOT3-A-V-ATXL.1h	Grey / šedá	HighPower LED	225 lm / 225 lm	LiFePo4 6,4V/1,0Ah	344-B-007-04-00-02	0,4 kg
LEDLUX-SPOT3-A-V-ATXL.3h	White / biela	HighPower LED	225 lm / 225 lm	LiFePo4 6,4V/2,0Ah	344-B-008-04-00-01	0,5 kg
LEDLUX-SPOT3-A-V-ATXL.3h	Grey / šedá	HighPower LED	225 lm / 225 lm	LiFePo4 6,4V/2,0Ah	344-B-008-04-00-02	0,5 kg

Page No.24

Wireless CENTRALTEST ELMAX-ATRF

Type	Colour	Light Source	Light Flux / Emergency	Battery	Order Code	Weight
LEDLUX-SPOT3-A-V-ATRF.1h	White / biela	HighPower LED	225 lm / 225 lm	LiFePo4 6,4V/1,0Ah	344-B-009-04-00-01	0,5 kg
LEDLUX-SPOT3-A-V-ATRF.1h	Grey / šedá	HighPower LED	225 lm / 225 lm	LiFePo4 6,4V/1,0Ah	344-B-009-04-00-02	0,5 kg

CENTRAL BATTERY (CBS)

Type	Colour	Version	Light Source	Light Flux	Order Code	Weight
C.LEDLUX-SPOT2-A-V/230V AC/DC	White / biela	CBS NON-ADDRESSABLE	HighPower LED	225 lm	182-B-303-00-00-01	0,4 kg
C.LEDLUX-SPOT2-A-V/230V AC/DC	Grey / šedá	CBS NON-ADDRESSABLE	HighPower LED	225 lm	182-B-303-00-00-02	0,4 kg
C.LEDLUX-SPOT2-A-V/24V AC/DC	White / biela	CBS NON-ADDRESSABLE	HighPower LED	225 lm	182-B-313-00-00-01	0,4 kg
C.LEDLUX-SPOT2-A-V/24V AC/DC	Grey / šedá	CBS NON-ADDRESSABLE	HighPower LED	225 lm	182-B-313-00-00-02	0,4 kg

DALI CENTRAL BATTERY (CBS)

Type	Colour	Version	Light Source	Light Flux	Order Code	Weight
C.LEDLUX-SPOT3-A-V-DALI 230V AC	White / biela	DALI CBS	HighPower LED	225 lm	344-B-012-00-00-01	0,4 kg
C.LEDLUX-SPOT3-A-V-DALI 230V AC	Grey / šedá	DALI CBS	HighPower LED	225 lm	344-B-012-00-00-02	0,4 kg

Look up pages No. 190-197 for 1lx Spacing tables
Pozri str.190-197 pre rozmiestnenie svetidiel na dosiahnutie 1lx

All LED parameters are describing the light source lm output. For the lighting calculation please use LDT file available on www.sec.sk
LED parametre sú platné pre LED svetelné zdroje samotné. Pre svetelno-technický výpočet použite LDT súbor na www.sec.sk



ANTIPANIC LIGHTING
LEDLUX-SPOT3-V



RECESSED ANTIPANIC LIGHTING LEDLUX-SPOT3-B-V



RAL9003



RAL9006



RAL9005

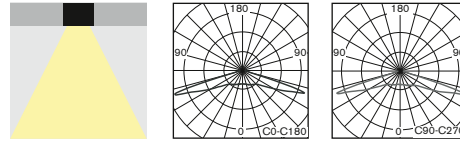

- Small and powerful **recessed LED** non-maintained (NM), maintained (M) or centralised (C) emergency lighting for perfect **wide beam** light distribution **especially designed for a large OPEN AREAS** such as **offices, shops, reception desks, lift areas, entrance halls, classrooms, etc.**
- It is available in all following versions:
- **AUTOTEST (-AT)**
- **DALI**
- **CENTRALTEST (-ATXL)** for **ELMAX LOOK** system (look up also page No.22)
- **CENTRALTEST (-ATRF)** for **ELMAX Wireless** system (page No.24)
- **CENTRAL BATTERY (C.LEDLUX-SPOT3)** for **non-addressable CBS**
- Conforming to the requirement of EN60598-2-22, EN1838, EN62034
- Design: plastic body in RAL9006 (grey) or RAL9003 (white) or RAL9005 (black)

- dizajnové, výkonné LED svetidlo pre **netrvalé (NM), trvalé (M)** alebo **centrálne (C)** núdzové osvetlenie pre zapustenú montáž zaručujúce vysokú hladinu svetelného toku **špeciálne navrhnuté pre osvetlenie otvorených priestorov** (vestibul, kancelária, reštaurácia, školské priestory,...) aj s funkciami:
- **AUTOTEST (-AT)**
- **DALI**
- **CENTRALTEST (-ATXL)** pre systém ELMAX LOOK (pozri str.22)
- **bezdrôtový CENTRALTEST (-ATRF)** pre ELMAX Wireless systém (str.24)
- **CENTRAL BATTERY (C.LEDLUX-SPOT3)** pre **neadresovateľné CBS**
- spĺňa požiadavky európskej normy EN 60598-2-22, EN1838, EN62034
- konštrukcia: teleso z plastu vo farbe RAL9006 (šedá) alebo RAL9003 (biela) alebo RAL9005 (čierna)

STANDARD FEATURES

ŠTANDARDNÁ VÝBAVA

- **High efficient HighPower (170lm/W) LONGLIFE LEDs (>100.000h)**
- **NEW Advanced Electronics**
- **LONGLIFE LiFePo4 battery**
- **Special LED lens** for perfect light distribution
- **Installation Mode** (battery protection, for more details look up page No.28)
- **Intelligent battery charging**
- **Addressable CENTRALTEST communication module** (for ATXL, ATRF only)
- LEDs indicating presence of power supply and signaling failures & TEST button
- **vysoko účinné HighPower LED (170lm/W) so životnosťou min.100000h**
- **progressívna elektronická jednotka**
- **LONGLIFE LiFePo4 batéria**
- špeciálna LED optika pre perfektnú distribúciu svetla
- **Inštaláčny mód** (ochrana batérie, pozri aj str.28)
- **Inteligentné nabíjanie batérie**
- adresovateľný CENTRALTEST komunikačný modul (len pre ATXL, ATRF verzie)
- signalizácia LED a TEST tlačítko

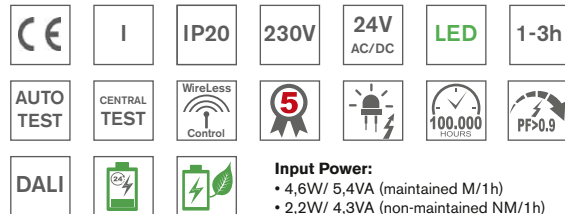

Input Power:

- 4,6W/ 5,4VA (maintained M/1h)
- 2,2W/ 4,3VA (non-maintained NM/1h)
- 3,1W/ 4,4VA (CBS)

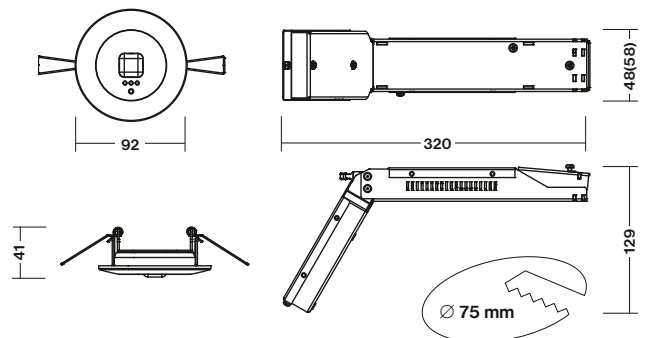

* Dimmensions in the bracket are valid for 3h versions
* rozmery v zátvorke platia pre 3h verzie

RECESSED ANTIPANIC LIGHTING LEDLUX-SPOT3-B-V



1LX SPACING TABLE / ROZMIESTNENIE PRE 1LX				
H (m)	X1 (m)	X2 (m)	Y1 (m)	Y2 (m)
2,75	2,5	10,0	2,5	10,0
3,00	2,2	8,8	2,2	8,8
3,50	1,0	7,0	1,1	7,0

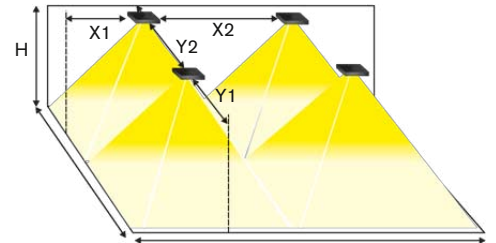

Page No.18

AUTOTEST -AT NM/M

Type	Colour	Light Source	Light Flux / Emergency mode	Battery	Order Code	Weight
LEDLUX-SPOT3-B-V-AT.1h	White / biela	HighPower LED	225 lm / 225 lm	LiFePo4 6,4V/1,0Ah	344-B-003-04-00-01	0,4 kg
LEDLUX-SPOT3-B-V-AT.1h	Grey / šedá	HighPower LED	225 lm / 225 lm	LiFePo4 6,4V/1,0Ah	344-B-003-04-00-02	0,4 kg
LEDLUX-SPOT3-B-V-AT.1h	Black / čierna	HighPower LED	225 lm / 225 lm	LiFePo4 6,4V/1,0Ah	344-B-003-04-00-03	0,4 kg
LEDLUX-SPOT3-B-V-AT.3h	White / biela	HighPower LED	225 lm / 225 lm	LiFePo4 6,4V/2,0Ah	344-B-004-04-00-01	0,5 kg
LEDLUX-SPOT3-B-V-AT.3h	Grey / šedá	HighPower LED	225 lm / 225 lm	LiFePo4 6,4V/2,0Ah	344-B-004-04-00-02	0,5 kg
LEDLUX-SPOT3-B-V-AT.3h	Black / čierna	HighPower LED	225 lm / 225 lm	LiFePo4 6,4V/2,0Ah	344-B-004-04-00-03	0,5 kg

DALI

Type	Colour	Light Source	Light Flux / Emergency mode	Battery	Order Code	Weight
LEDLUX-SPOT3-B-V-DALI.1h	White / biela	HighPower LED	225 lm / 225 lm	LiFePo4 6,4V/1,0Ah	344-B-013-04-00-01	0,4 kg
LEDLUX-SPOT3-B-V-DALI.1h	Grey / šedá	HighPower LED	225 lm / 225 lm	LiFePo4 6,4V/1,0Ah	344-B-013-04-00-02	0,4 kg
LEDLUX-SPOT3-B-V-DALI.3h	White / biela	HighPower LED	225 lm / 225 lm	LiFePo4 6,4V/2,0Ah	344-B-014-04-00-01	0,5 kg
LEDLUX-SPOT3-B-V-DALI.3h	Grey / šedá	HighPower LED	225 lm / 225 lm	LiFePo4 6,4V/2,0Ah	344-B-014-04-00-02	0,5 kg

Page No.22

CENTRALTEST -ATXL ELMAX-LOOK

Type	Colour	Light Source	Light Flux / Emergency mode	Battery	Order Code	Weight
LEDLUX-SPOT3-B-V-ATXL.1h	White / biela	HighPower LED	225 lm / 225 lm	LiFePo4 6,4V/1,0Ah	344-B-015-04-00-01	0,4 kg
LEDLUX-SPOT3-B-V-ATXL.1h	Grey / šedá	HighPower LED	225 lm / 225 lm	LiFePo4 6,4V/1,0Ah	344-B-015-04-00-02	0,4 kg
LEDLUX-SPOT3-B-V-ATXL.3h	White / biela	HighPower LED	225 lm / 225 lm	LiFePo4 6,4V/2,0Ah	344-B-016-04-00-01	0,5 kg
LEDLUX-SPOT3-B-V-ATXL.3h	Grey / šedá	HighPower LED	225 lm / 225 lm	LiFePo4 6,4V/2,0Ah	344-B-016-04-00-02	0,5 kg

Page No.24

Wireless CENTRALTEST ELMAX-ATRF

Type	Colour	Light Source	Light Flux / Emergency mode	Battery	Order Code	Weight
LEDLUX-SPOT3-B-V-ATRF.1h	White / biela	HighPower LED	225 lm / 225 lm	LiFePo4 6,4V/1,0Ah	344-B-017-04-00-01	0,5 kg
LEDLUX-SPOT3-B-V-ATRF.1h	Grey / šedá	HighPower LED	225 lm / 225 lm	LiFePo4 6,4V/1,0Ah	344-B-017-04-00-02	0,5 kg

CENTRAL BATTERY (CBS)

Type	Colour	Version	Light Source	Light Flux	Order Code	Weight
C.LEDLUX-SPOT2-B-V 230V AC/DC	White / biela	CBS NON-ADDRESSABLE	HighPower LED	225 lm	182-B-304-00-00-01	0,4 kg
C.LEDLUX-SPOT2-B-V 230V AC/DC	Grey / šedá	CBS NON-ADDRESSABLE	HighPower LED	225 lm	182-B-304-00-00-02	0,4 kg
C.LEDLUX-SPOT2-B-V 24V AC/DC	White / biela	CBS NON-ADDRESSABLE	HighPower LED	225 lm	182-B-319-00-00-01	0,4 kg
C.LEDLUX-SPOT2-B-V 24V AC/DC	Grey / šedá	CBS NON-ADDRESSABLE	HighPower LED	225 lm	182-B-319-00-00-02	0,4 kg

CENTRAL BATTERY (CBS)

Type	Colour	Version	Light Source	Light Flux	Order Code	Weight
C.LEDLUX-SPOT3-B-V-DALI 230V AC	White / biela	DALI CBS	HighPower LED	225 lm	344-B-020-00-00-01	0,4 kg
C.LEDLUX-SPOT3-B-V-DALI 230V AC	Grey / šedá	DALI CBS	HighPower LED	225 lm	344-B-020-00-00-02	0,4 kg

Look up pages No. 190-197 for 1lx Spacing tables
Pozri str.190-197 pre rozmiestnenie svetidiel na dosiahnutie 1lx

All LED parameters are describing the light source lm output. For the lighting calculation please use LDT file available on www.sec.sk
LED parametre sú platné pre LED svetelné zdroje samotné. Pre svetelno-technický výpočet použite LDT súbor na www.sec.sk

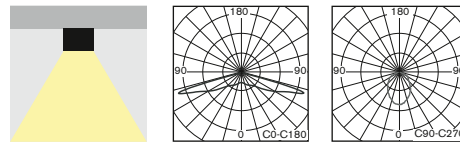

- Small and powerful **surface mounted LED** non-maintained (NM), maintained (M) or centralised (C) emergency lighting for perfect light distribution **especially designed for a corridor applications (escape route illumination to EN1838)**. It is available in all following versions:

- **AUTOTEST** (-AT)
- **DALI**
- **CENTRALTEST** (-ATXL) for **ELMAX LOOK** system (look up also page No.22)
- **CENTRALTEST** (-ATRF) for **ELMAX Wireless** system (look up page No.24)
- **CENTRAL BATTERY** (C.LEDLUX-SPOT3) for **non-addressable CBS**
- Conforming to the requirement of EN60598-2-22, EN1838, EN62034
- Design: plastic body in RAL9006 (grey) or RAL9003 (white) or RAL9005 (black)
- dizajnové, výkonné LED svietidlo pre **netrvalé (NM), trvalé (M)** alebo **centrálne (C)** núdzové osvetlenie pre povrchovú montáž zaručujúce **vyšokú hladinu svetelného toku špeciálne navrhnuté pre osvetlenie chodieb**, aj s funkciami:
- **AUTOTEST** (-AT)
- **DALI**
- **CENTRALTEST** (-ATXL) pre systém ELMAX LOOK (pozri str.22)
- **bezdrôtový CENTRALTEST** (-ATRF) pre ELMAX-Wireless systém (str.24)
- **CENTRAL BATTERY** (C.LEDLUX-SPOT3) pre **neadresovateľné CBS**
- spĺňa požiadavky európskej normy EN 60598-2-22, EN1838, EN62034
- konštrukcia: teleso z plastu vo farbe RAL9006 (šedá) alebo RAL9003 (biela) alebo RAL9005 (čierna)

STANDARD FEATURES

STANDARDNÁ VÝBAVA

- **High efficient HighPower (170lm/W) LONGLIFE LEDs (>100.000h)**
- **NEW Advanced Electronics**
- **LONGLIFE LiFePo4 battery**
- **Special LED lens** for perfect light distribution
- **Installation Mode** (battery protection, for more details look up page No.28)
- **Intelligent battery charging**
- Addressable **CENTRALTEST** communication module (for ATXL, ATRF only)
- LEDs indicating presence of power supply and signaling failures & TEST button
- **vyšokú účinnú HighPower LED (170lm/W) so životnosťou min.100000h**
- **progresívna elektronická jednotka**
- **LONGLIFE LiFePo4 batéria**
- špeciálna LED optika pre perfektnú distribúciu svetla
- **Instalačný mód** (ochrana batérie, pozri aj str.28)
- **Inteligentné nabíjanie batérie**
- adresovateľný **CENTRALTEST** komunikačný modul (len pre ATXL a ATRF verzie)
- signalizácia LED a TEST tlačítko

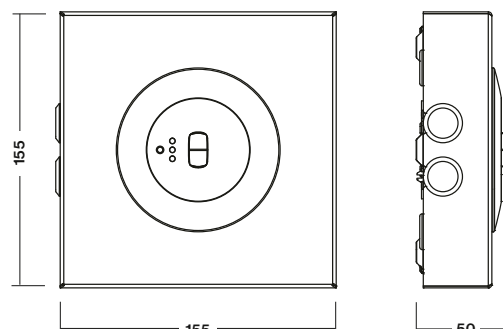
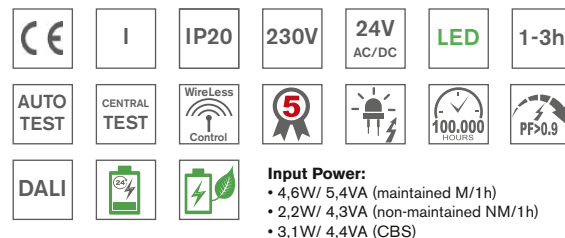

CEILING ESCAPE ROUTE LIGHTING LEDLUX-SPOT3-A-P



1LX SPACING TABLE / ROZMIESTNENIE PRE 1LX		
H (m)	Y1 (m)	Y2 (m)
2,75	8,5	20,5
3,00	8,7	21,5
3,50	9,2	22,5
4,00	8,5	23,5

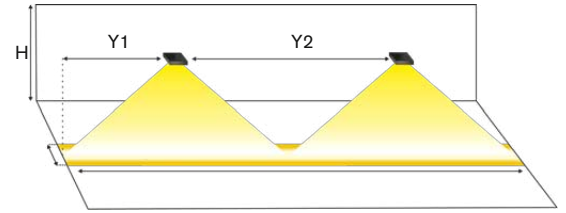

Page No.18

AUTOTEST -AT NM/M

Type	Colour	Light Source	Light Flux / Emergency mode	Battery	Order Code	Weight
LEDLUX-SPOT3-A-P-AT.1h	White / biela	HighPower LED	225 lm / 225 lm	LiFePo4 6,4V/1,0Ah	344-B-101-04-00-01	0,5 kg
LEDLUX-SPOT3-A-P-AT.1h	Grey / šedá	HighPower LED	225 lm / 225 lm	LiFePo4 6,4V/1,0Ah	344-B-101-04-00-02	0,5 kg
LEDLUX-SPOT3-A-P-AT.1h	Black / čierna	HighPower LED	225 lm / 225 lm	LiFePo4 6,4V/1,0Ah	344-B-101-04-00-03	0,5 kg
LEDLUX-SPOT3-A-P-AT.3h	White / biela	HighPower LED	225 lm / 225 lm	LiFePo4 6,4V/2,0Ah	344-B-102-04-00-01	0,6 kg
LEDLUX-SPOT3-A-P-AT.3h	Grey / šedá	HighPower LED	225 lm / 225 lm	LiFePo4 6,4V/2,0Ah	344-B-102-04-00-02	0,6 kg
LEDLUX-SPOT3-A-P-AT.3h	Black / čierna	HighPower LED	225 lm / 225 lm	LiFePo4 6,4V/2,0Ah	344-B-102-04-00-03	0,6 kg

DALI SELF-CONTAINED

Type	Colour	Light Source	Light Flux / Emergency	Battery	Order Code	Weight
LEDLUX-SPOT3-A-P-DALI.1h	White / biela	HighPower LED	225 lm / 225 lm	LiFePo4 6,4V/1,0Ah	344-B-105-04-00-01	0,5 kg
LEDLUX-SPOT3-A-P-DALI.1h	Grey / šedá	HighPower LED	225 lm / 225 lm	LiFePo4 6,4V/1,0Ah	344-B-105-04-00-02	0,5 kg
LEDLUX-SPOT3-A-P-DALI.3h	White / biela	HighPower LED	225 lm / 225 lm	LiFePo4 6,4V/2,0Ah	344-B-106-04-00-01	0,6 kg
LEDLUX-SPOT3-A-P-DALI.3h	Grey / šedá	HighPower LED	225 lm / 225 lm	LiFePo4 6,4V/2,0Ah	344-B-106-04-00-02	0,6 kg

Page No.22

CENTRALTEST -ATXL ELMAX-LOOK

Type	Colour	Light Source	Light Flux / Emergency mode	Battery	Order Code	Weight
LEDLUX-SPOT3-A-P-ATXL.1h	White / biela	HighPower LED	225 lm / 225 lm	LiFePo4 6,4V/1,0Ah	344-B-107-04-00-01	0,5 kg
LEDLUX-SPOT3-A-P-ATXL.1h	Grey / šedá	HighPower LED	225 lm / 225 lm	LiFePo4 6,4V/1,0Ah	344-B-107-04-00-02	0,5 kg
LEDLUX-SPOT3-A-P-ATXL.3h	White / biela	HighPower LED	225 lm / 225 lm	LiFePo4 6,4V/2,0Ah	344-B-108-04-00-01	0,6 kg
LEDLUX-SPOT3-A-P-ATXL.3h	Grey / šedá	HighPower LED	225 lm / 225 lm	LiFePo4 6,4V/2,0Ah	344-B-108-04-00-02	0,6 kg

Page No.24

Wireless CENTRALTEST ELMAX-ATRF

Type	Colour	Light Source	Light Flux / Emergency	Battery	Order Code	Weight
LEDLUX-SPOT3-A-P-ATRF.1h	White / biela	HighPower LED	225 lm / 225 lm	LiFePo4 6,4V/1,0Ah	344-B-109-04-00-01	0,6 kg
LEDLUX-SPOT3-A-P-ATRF.1h	Grey / šedá	HighPower LED	225 lm / 225 lm	LiFePo4 6,4V/1,0Ah	344-B-109-04-00-02	0,6 kg

CENTRAL BATTERY (CBS)

Type	Colour	Version	Light Source	Light Flux	Order Code	Weight
C.LEDLUX-SPOT2-A-P/230V AC/DC	White / biela	CBS NON-ADDRESSABLE	HighPower LED	225 lm	182-B-204-00-00-01	0,5 kg
C.LEDLUX-SPOT2-A-P/230V AC/DC	Grey / šedá	CBS NON-ADDRESSABLE	HighPower LED	225 lm	182-B-204-00-00-02	0,5 kg
C.LEDLUX-SPOT2-A-P/24V AC/DC	White / biela	CBS NON-ADDRESSABLE	HighPower LED	225 lm	182-B-212-00-00-01	0,5 kg
C.LEDLUX-SPOT2-A-P/24V AC/DC	Grey / šedá	CBS NON-ADDRESSABLE	HighPower LED	225 lm	182-B-212-00-00-02	0,5 kg

DALI CENTRAL BATTERY (CBS)

Type	Colour	Version	Light Source	Light Flux	Order Code	Weight
C.LEDLUX-SPOT3-A-P-DALI 230V AC	White / biela	DALI CBS	HighPower LED	225 lm	344-B-112-00-00-01	0,5 kg
C.LEDLUX-SPOT3-A-P-DALI 230V AC	Grey / šedá	DALI CBS	HighPower LED	225 lm	344-B-112-00-00-02	0,5 kg

Look up pages No. 190-197 for 1lx Spacing tables
Pozri str.190-197 pre rozmiestnenie svetidiel na dosiahnutie 1lx

All LED parameters are describing the light source lm output. For the lighting calculation please use LDT file available on www.sec.sk
LED parametre sú platné pre LED svetelné zdroje samotné. Pre svetelno-technický výpočet použite LDT súbor na www.sec.sk

CEILING ESCAPE ROUTE LIGHTING LEDLUX-SPOT3-A-P



Light source	LED 5000K
Installed load	4.6W/5.4VA (maintained M)
	2.2W/4.3VA (non-maintained NM)
	2.7W/4.6VA (CBS)
Housing colour	RAL9003 White
	RAL9006 Grey
Application	Escape route lighting
Max luminaire spacing	up to 23,5m > 1lx

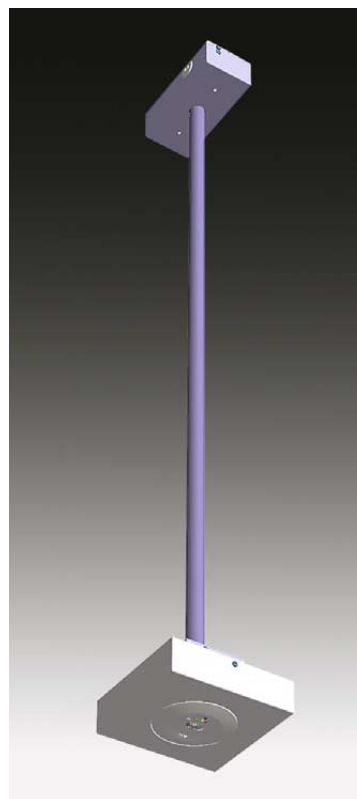

Optional Ceiling Bracket <1050mm long (for LEDLUX-SPOT3-A-P or B-P)
Príplatková závesná konzola dĺžka <1050mm (pre LEDLUX-SPOT3-A-P alebo -B-P)
Order Code: 182-B-201-01-00-01 (white RAL9003)
Order Code: 182-B-201-01-00-02 (grey RAL9006)

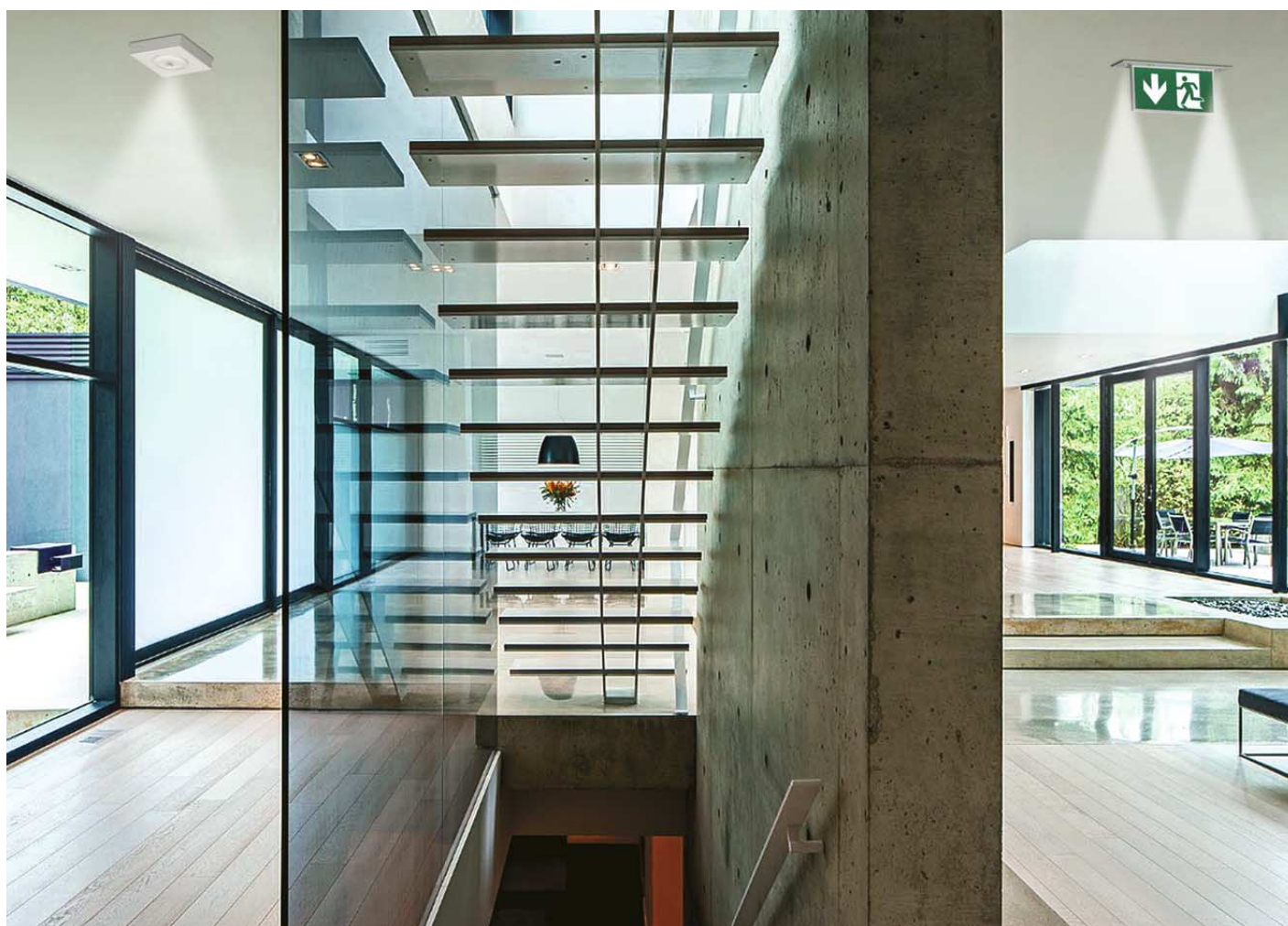

Light source	LED 5000K
Installed load	4.6W/5.4VA (maintained M) 2.2W/4.3VA (non-maintained NM) 2.7W/4.6VA (CBS)
Housing colour	RAL9003 White RAL9006 Grey
Application	Anti-panic lighting
Max room illumination	up to 80m² > 0.5lx

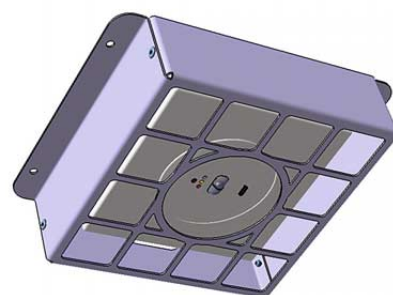

Optional Protective Cage
Príplatková ochranná mreža
Order Code: 182-B-202-00-00-01
(for LEDLUX-SPOT3-A-P or -B-P versions)



CEILING ANTIPANIC LIGHTING
LEDLUX-SPOT3-B-P



RAL9003



RAL9006



RAL9005

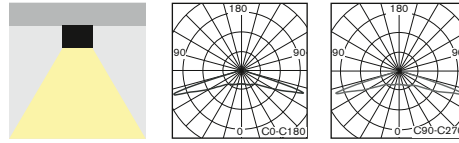

- Powerfull **surface mounted LED** non-maintained (NM), maintained (M) or centralised (C) emergency lighting for perfect **wide beam** light distribution **especially** designed for a **large OPEN AREAS** such as **offices, shops, reception desks, lift areas, entrance halls, classrooms, etc.** It is available in all following versions:
 - **AUTOTEST** (-AT)
 - **DALI**
 - **CENTRALTEST** (-ATXL) for **ELMAX LOOK** system (look up also page No.22)
 - **CENTRALTEST** (-ATRF) for **ELMAX Wireless** system (look up page No.24)
 - **CENTRAL BATTERY** (C.LEDLUX-SPOT3) for **non-addressable CBS**
 - Conforming to the requirement of EN60598-2-22, EN1838, EN62034
 - Design: plastic body in RAL9006 (grey) or RAL9003 (white) or RAL9005 (black)

- Diajnové a výkonné LED SPOT svetidlo pre **netrvalé (NM), trvalé (M)** alebo **centrálne (C)** núdzové osvetlenie pre povrchovú montáž zaručujúce vysokú hladinu svetelného toku so širokou krivkou svetiovosti špeciálne navrhnuté pre osvetlenie rozlohou veľkých otvorených priestorov ako napr. kancelárie, obchody, recepcie, nástupný priestor výťahov, vstupné haly školské triedy a pod., aj s funkciami:
 - **AUTOTEST** (-AT)
 - **DALI**
 - **CENTRALTEST** (-ATXL) pre systém ELMAX LOOK (pozri str.22)
 - **bezdrôtový CENTRALTEST** (-ATRF) pre ELMAX-Wireless systém (str.24)
 - **CENTRAL BATTERY** (C.LEDLUX-SPOT3) pre **neadresovateľné CBS**

- spĺňa požiadavky európskej normy EN 60598-2-22, EN1838, EN62034
- konštrukcia: teleso z plastu vo farbe RAL9006 (šedá) alebo RAL9003 (biela) alebo RAL9005 (čierna)

STANDARD FEATURES

ŠTANDARDNÁ VÝBAVA

- **High efficient HighPower (170lm/W) LONGLIFE LEDs (>100.000h)**
- **NEW Advanced Electronics**
- **LONGLIFE LiFePo4 Battery**
- **Special LED lens** for perfect light distribution
- **Installation Mode** (battery protection, for more details look up page No.28)
- **Intelligent battery charging**
- Addressable **CENTRALTEST** communication module (for ATXL or ATRF only)
- LEDs indicating presence of power supply and signaling failures & **TEST** button
- **vysoko účinné HighPower LED (170lm/W) so životnosťou min.100000h**
- **progresívna elektronická jednotka**
- **LONGLIFE LiFePo4 batéria**
- špeciálna LED optika pre perfektnú distribúciu svetla
- **Inštalčný mód** (ochrana batérie, pozri aj str.28)
- **Inteligentné nabíjanie batérie**
- adresovateľný **CENTRALTEST** komunikačný modul (len pre ATXL a ATRF verzie)
- signalizácia LED a **TEST** tlačítko

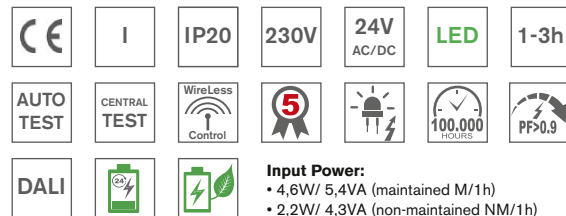

Input Power:

- 4,6W/ 5,4VA (maintained M/1h)
- 2,2W/ 4,3VA (non-maintained NM/1h)
- 3,1W/ 4,4VA (CBS)

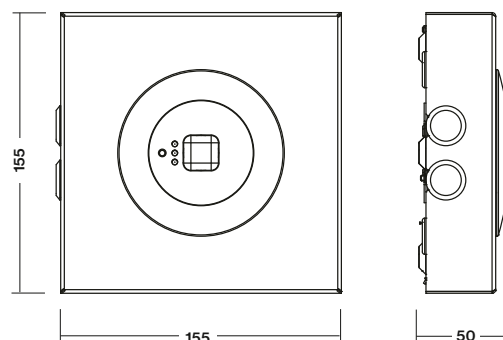



1LX SPACING TABLE / ROZMIESTNENIE PRE 1LX				
H (m)	X1 (m)	X2 (m)	Y1 (m)	Y2 (m)
2,75	2,5	10,0	2,5	10,0
3,00	2,2	8,8	2,2	8,8
3,50	1,0	7,0	1,1	7,0

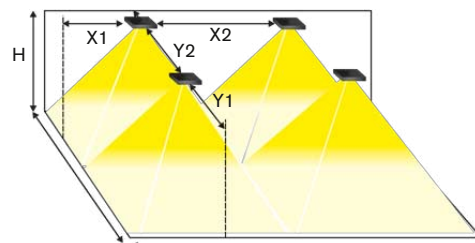

Page No.18

AUTOTEST -AT NM/M

Type	Colour	Light Source	Light Flux / Emergency mode	Battery	Order Code	Weight
LEDLUX-SPOT3-B-P-AT.1h	White / biela	HighPower LED	225 lm / 225 lm	LiFePo4 6,4V/1,0Ah	344-B-103-04-00-01	0,5 kg
LEDLUX-SPOT3-B-P-AT.1h	Grey / šedá	HighPower LED	225 lm / 225 lm	LiFePo4 6,4V/1,0Ah	344-B-103-04-00-02	0,5 kg
LEDLUX-SPOT3-B-P-AT.1h	Black / čierna	HighPower LED	225 lm / 225 lm	LiFePo4 6,4V/1,0Ah	344-B-103-04-00-03	0,5 kg
LEDLUX-SPOT3-B-P-AT.3h	White / biela	HighPower LED	225 lm / 225 lm	LiFePo4 6,4V/2,0Ah	344-B-104-04-00-01	0,6 kg
LEDLUX-SPOT3-B-P-AT.3h	Grey / šedá	HighPower LED	225 lm / 225 lm	LiFePo4 6,4V/2,0Ah	344-B-104-04-00-02	0,6 kg
LEDLUX-SPOT3-B-P-AT.3h	Black / čierna	HighPower LED	225 lm / 225 lm	LiFePo4 6,4V/2,0Ah	344-B-104-04-00-03	0,6 kg

DALI SELF-CONTAINED

Type	Colour	Light Source	Light Flux / Emergency	Battery	Order Code	Weight
LEDLUX-SPOT3-B-P-DALI.1h	White / biela	HighPower LED	225 lm / 225 lm	LiFePo4 6,4V/1,0Ah	344-B-113-04-00-01	0,5 kg
LEDLUX-SPOT3-B-P-DALI.1h	Grey / šedá	HighPower LED	225 lm / 225 lm	LiFePo4 6,4V/1,0Ah	344-B-113-04-00-02	0,5 kg
LEDLUX-SPOT3-B-P-DALI.3h	White / biela	HighPower LED	225 lm / 225 lm	LiFePo4 6,4V/2,0Ah	344-B-114-04-00-01	0,6 kg
LEDLUX-SPOT3-B-P-DALI.3h	Grey / šedá	HighPower LED	225 lm / 225 lm	LiFePo4 6,4V/2,0Ah	344-B-114-04-00-02	0,6 kg

Page No.22

CENTRALTEST -ATXL ELMAX-LOOK

Type	Colour	Light Source	Light Flux / Emergency mode	Battery	Order Code	Weight
LEDLUX-SPOT3-B-P-ATXL.1h	White / biela	HighPower LED	225 lm / 225 lm	LiFePo4 6,4V/1,0Ah	344-B-115-04-00-01	0,5 kg
LEDLUX-SPOT3-B-P-ATXL.1h	Grey / šedá	HighPower LED	225 lm / 225 lm	LiFePo4 6,4V/1,0Ah	344-B-115-04-00-02	0,5 kg
LEDLUX-SPOT3-B-P-ATXL.3h	White / biela	HighPower LED	225 lm / 225 lm	LiFePo4 6,4V/2,0Ah	344-B-116-04-00-01	0,6 kg
LEDLUX-SPOT3-B-P-ATXL.3h	Grey / šedá	HighPower LED	225 lm / 225 lm	LiFePo4 6,4V/2,0Ah	344-B-116-04-00-02	0,6 kg

Page No.24

Wireless CENTRALTEST ELMAX-ATRF

Type	Colour	Light Source	Light Flux / Emergency	Battery	Order Code	Weight
LEDLUX-SPOT3-B-P-ATRF.1h	White / biela	HighPower LED	225 lm / 225 lm	LiFePo4 6,4V/1,0Ah	344-B-117-04-00-01	0,6 kg
LEDLUX-SPOT3-B-P-ATRF.1h	Grey / šedá	HighPower LED	225 lm / 225 lm	LiFePo4 6,4V/1,0Ah	344-B-117-04-00-02	0,6 kg

CENTRAL BATTERY (CBS)

Type	Colour	Version	Light Source	Light Flux	Order Code	Weight
C.LEDLUX-SPOT2-B-P/230V AC/DC	White / biela	CBS NON-ADDRESSABLE	HighPower LED	225 lm	182-B-201-00-00-01	0,5 kg
C.LEDLUX-SPOT2-B-P/230V AC/DC	Grey / šedá	CBS NON-ADDRESSABLE	HighPower LED	225 lm	182-B-201-00-00-02	0,5 kg
C.LEDLUX-SPOT2-B-P/24V AC/DC	White / biela	CBS NON-ADDRESSABLE	HighPower LED	225 lm	182-B-220-00-00-01	0,5 kg
C.LEDLUX-SPOT2-B-P/24V AC/DC	Grey / šedá	CBS NON-ADDRESSABLE	HighPower LED	225 lm	182-B-220-00-00-02	0,5 kg

DALI CENTRAL BATTERY (CBS)

Type	Colour	Version	Light Source	Light Flux	Order Code	Weight
C.LEDLUX-SPOT3-B-P-DALI 230V AC	White / biela	DALI CBS	HighPower LED	225 lm	344-B-120-00-00-01	0,5 kg
C.LEDLUX-SPOT3-B-P-DALI 230V AC	Grey / šedá	DALI CBS	HighPower LED	225 lm	344-B-120-00-00-02	0,5 kg

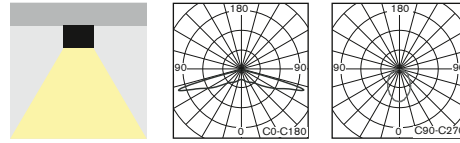

• Powerfull **surface mounted LED SPOT** fixture for either non-maintained (NM), maintained (M) or centralised (C) emergency lighting for perfect light distribution **especially designed for a corridor applications (escape route illumination to EN1838) where IP65 is required.**

It is available in all following versions:

- **AUTOTEST** (-AT)
- **DALI**
- **CENTRALTEST** (-ATXL) for **ELMAX LOOK** system (look up also page No.22)
- **CENTRALTEST** (-ATRF) for **ELMAX Wireless** system (look up page No.24)
- **CENTRAL BATTERY** (C.LEDLUX-SPOT3) for **non-addressable CBS**
- Conforming to the requirement of EN60598-2-22, EN1838, EN62034
- Design: plastic body in RAL7035

• výkonné LED SPOT svetidlo pre **netrvalé (NM), trvalé (M)** alebo **centrálne (C)** núdzové osvetlenie pre povrchovú montáž zaručujúce **vyšokú hladinu svetelného toku špeciálne navrhnuté pre osvetlenie chodieb v aplikáciách, kde je vyžadované IP65**, aj s funkciami:

- **AUTOTEST** (-AT)
- **DALI**
- **CENTRALTEST** (-ATXL) pre systém ELMAX LOOK (pozri str.22)
- **bezdrôtový CENTRALTEST** (-ATRF) pre ELMAX-Wireless systém (str.24)
- **CENTRAL BATTERY** (C.LEDLUX-SPOT3) pre **neadresovateľné CBS**
- spĺňa požiadavky európskej normy EN 60598-2-22, EN1838, EN62034
- konštrukcia: teleso z plastu vo farbe RAL9006 (šedá) alebo RAL9003 (biela)

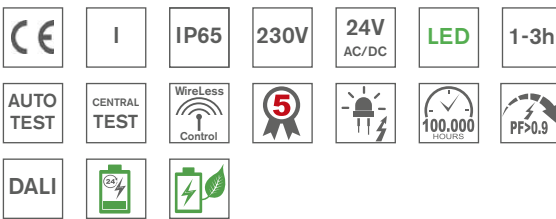

Input Power:

- 4,6W/ 5,4VA (maintained M/1h)
- 2,2W/ 4,3VA (non-maintained NM/1h)
- 3,1W/ 4,4VA (CBS)

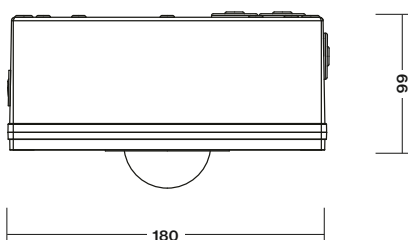
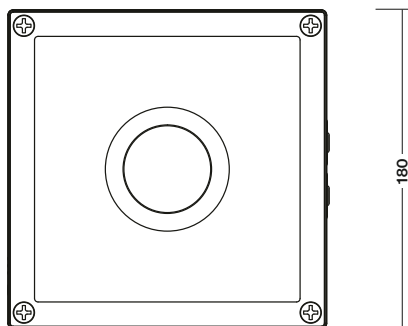

STANDARD FEATURES

ŠTANDARDNÁ VÝBAVA

- **High efficient HighPower (170lm/W) LONGLIFE LEDs (>100.000h)**
- **NEW Advanced Electronics**
- **LONGLIFE LiFePo4 battery**
- **Special LED lens** for perfect light distribution
- **Installation Mode** (battery protection, for more details look up page No.28)
- **Intelligent battery charging**
- Addressable CENTRALTEST communication module (for ATXL, ATRF only)
- LEDs indicating presence of power supply and signaling failures & TEST button
- **vysoko účinné HighPower LED (170lm/W) so životnosťou min.100000h**
- **progresívna elektronická jednotka**
- **LONGLIFE LiFePo4 batéria**
- špeciálna LED optika pre perfektnú distribúciu svetla
- **Inštaláčny mód** (ochrana batérie, pozri aj str.28)
- **Inteligentné nabíjanie batérie**
- adresovateľný CENTRALTEST komunikačný modul (len pre ATXL, ATRF verzie)
- signalizácia LED a TEST tlačítko



1LX SPACING TABLE / ROZMIESTNENIE PRE 1LX		
H (m)	Y1 (m)	Y2 (m)
2,75	7,5	20,5
3,00	8,7	21,5
3,50	9,2	22,5
4,00	8,5	23,5

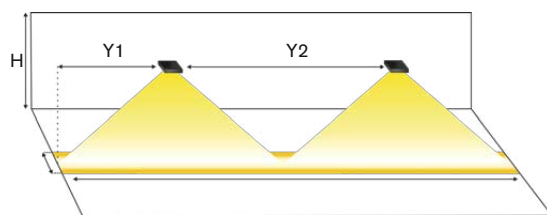

Page No.18

AUTOTEST -AT NM/M

Type	Light Source	Light Flux / Emergency mode	Battery	Order Code	Weight
LEDLUX-SPOT3-A-P-AT.1h IP65	HighPower LED	225 lm / 225 lm	LiFePo4 6,4V/1,0Ah	344-B-201-04-00-00	0,7 kg
LEDLUX-SPOT3-A-P-AT.3h IP65	HighPower LED	225 lm / 225 lm	LiFePo4 6,4V/2,0Ah	344-B-202-04-00-00	0,8 kg

DALI SELF-CONTAINED

Type	Light Source	Light Flux / Emergency	Battery	Order Code	Weight
LEDLUX-SPOT3-A-P-DALI.1h IP65	HighPower LED	225 lm / 225 lm	LiFePo4 6,4V/1,0Ah	344-B-205-04-00-00	0,7 kg
LEDLUX-SPOT3-A-P-DALI.3h IP65	HighPower LED	225 lm / 225 lm	LiFePo4 6,4V/2,0Ah	344-B-206-04-00-00	0,8 kg

Page No.22

CENTRALTEST -ATXL ELMAX-LOOK

Type	Light Source	Light Flux / Emergency mode	Battery	Order Code	Weight
LEDLUX-SPOT3-A-P-ATXL.1h IP65	HighPower LED	225 lm / 225 lm	LiFePo4 6,4V/1,0Ah	344-B-207-04-00-00	0,7 kg
LEDLUX-SPOT3-A-P-ATXL.3h IP65	HighPower LED	225 lm / 225 lm	LiFePo4 6,4V/2,0Ah	344-B-208-04-00-00	0,8 kg

Page No.24

Wireless CENTRALTEST ELMAX-ATRF

Type	Light Source	Light Flux / Emergency	Battery	Order Code	Weight
LEDLUX-SPOT3-A-P-ATRF.1h	HighPower LED	225 lm / 225 lm	LiFePo4 6,4V/1,0Ah	344-B-209-04-00-00	0,7 kg
LEDLUX-SPOT3-A-P-ATRF.3h	HighPower LED	225 lm / 225 lm	LiFePo4 6,4V/2,0Ah	344-B-210-04-00-00	0,8 kg

CENTRAL BATTERY (CBS)

Type	Version	Light Source	Light Flux	Order Code	Weight
C.LEDLUX-SPOT3-A-P IP65 230V AC/DC	CBS NON-ADDRESSABLE	HighPower LED	225 lm	344-B-211-00-00-00	0,6 kg
C.LEDLUX-SPOT3-A-P IP65 24V AC/DC	CBS NON-ADDRESSABLE	HighPower LED	225 lm	344-B-212-00-00-00	0,6 kg

DALI CENTRAL BATTERY (CBS)

Type	Version	Light Source	Light Flux	Order Code	Weight
C.LEDLUX-SPOT3-A-P-DALI IP65 230V AC	DALI CBS	HighPower LED	225 lm	344-B-213-00-00-00	0,6 kg

Look up pages No. 190-197 for 1lx Spacing tables
Pozri str.190-197 pre rozmiestnenie svetidiel na dosiahnutie 1lx

All LED parameters are describing the light source lm output. For the lighting calculation please use LDT file available on www.sec.sk
LED parametre sú platné pre LED svetelné zdroje samotné. Pre svetelno-technický výpočet použite LDT súbor na www.sec.sk

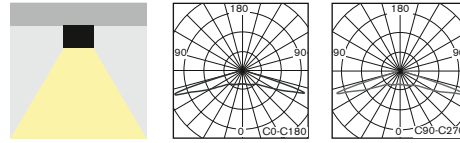

- Powerfull **surface mounted LED** non-maintained (NM), maintained (M) or centralised (C) emergency lighting for perfect **wide beam** light distribution **especially designed for a large OPEN AREAS** such as **production halls, storage areas, etc.... where IP65 is required**
- It is available in all following versions:

- **AUTOTEST** (-AT)
- **DALI**
- **CENTRALTEST** (-ATXL) for **ELMAX LOOK** system (look up also page No.22)
- **CENTRALTEST** (-ATRF) for **ELMAX Wireless** system (look up page No.24)
- **CENTRAL BATTERY** (C.LEDLUX-SPOT3) for **non-addressable CBS**
- Conforming to the requirement of EN60598-2-22, EN1838, EN62034
- Design: plastic body in RAL7035

- Výkonné LED SPOT svetidlo pre **netrvalé (NM), trvalé (M)** alebo **centrálne (C)** núdzové osvetlenie pre povrchovú montáž zaručujúce vysokú hladinu svetelného toku so širokou krivkou svietivosti špeciálne navrhnuté pre osvetlenie rozlohou veľkých otvorených priestorov ako napr. výrobné haly, skladovacie priestory a pod.... kde je navyše IP65 požadované., aj s funkciami:

- **AUTOTEST** (-AT)
- **DALI**
- **CENTRALTEST** (-ATXL) pre systém ELMAX LOOK (pozri str.22)
- **bezdrôtový CENTRALTEST** (-ATRF) pre ELMAX-Wireless systém (str.24)
- **CENTRAL BATTERY** (C.LEDLUX-SPOT3) pre **neadresovateľné CBS**
- spĺňa požiadavky európskej normy EN 60598-2-22, EN1838, EN62034
- konštrukcia: teleso z plastu vo farbe RAL7035

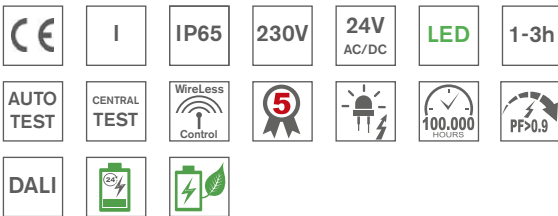

Input Power:

- 4,6W/ 5,4VA (maintained M/1h)
- 2,2W/ 4,3VA (non-maintained NM/1h)
- 3,1W/ 4,4VA (CBS)

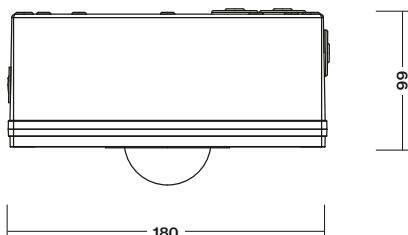
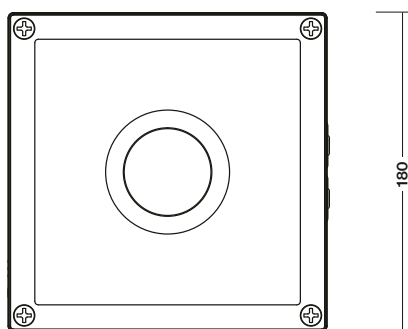

STANDARD FEATURES

ŠTANDARDNÁ VÝBAVA

- **High efficient HighPower (170lm/W) LONGLIFE LEDs (>100.000h)**
- **NEW Advanced Electronics**
- **LONGLIFE LiFePo4 battery**
- **Special LED lens** for perfect light distribution
- **Installation Mode** (battery protection, for more details look up page No.28)
- **Intelligent battery charging**
- Addressable CENTRALTEST communication module (for ATXL, ATRF only)
- LEDs indicating presence of power supply and signaling failures & TEST button
- **vysoko účinné HighPower LED (170lm/W) so životnosťou min.100000h**
- **progresívna elektronická jednotka**
- **LONGLIFE LiFePo4 batéria**
- špeciálna LED optika pre perfektnú distribúciu svetla
- **Inštaláčny mód** (ochrana batérie, pozri aj str.28)
- **Inteligentné nabíjanie batérie**
- adresovateľný CENTRALTEST komunikačný modul (len pre ATXL, ATRF verzie)
- signalizácia LED a TEST tlačítko

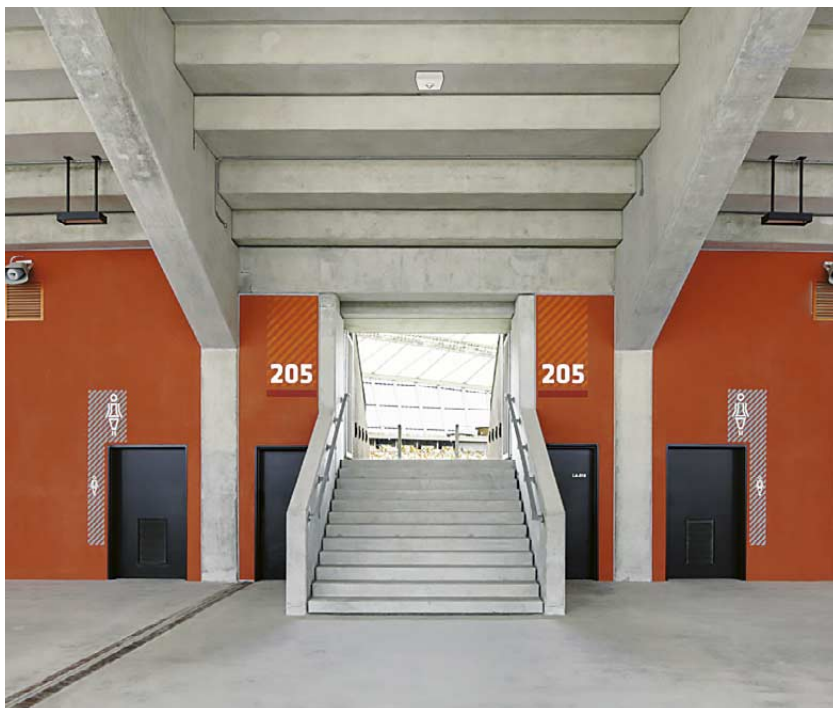

1LX SPACING TABLE / ROZMIESTNENIE PRE 1LX				
H (m)	X1 (m)	X2 (m)	Y1 (m)	Y2 (m)
2,75	2,5	9,5	2,5	9,5
3,00	2,0	8,3	2,0	8,3
3,50	1,0	6,8	1,0	6,8

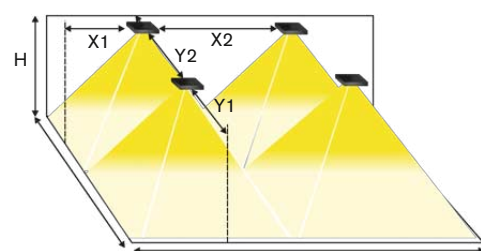

Page No.18

AUTOTEST -AT NM/M

Type	Light Source	Light Flux / Emergency mode	Battery	Order Code	Weight
LEDLUX-SPOT3-B-P-AT.1h IP65	HighPower LED	225 lm / 225 lm	LiFePo4 6,4V/1,0Ah	344-B-203-04-00-00	0,7 kg
LEDLUX-SPOT3-B-P-AT.3h IP65	HighPower LED	225 lm / 225 lm	LiFePo4 6,4V/2,0Ah	344-B-204-04-00-00	0,8 kg

DALI SELF-CONTAINED

Type	Light Source	Light Flux / Emergency	Battery	Order Code	Weight
LEDLUX-SPOT3-B-P-DALI.1h IP65	HighPower LED	225 lm / 225 lm	LiFePo4 6,4V/1,0Ah	344-B-214-04-00-00	0,7 kg
LEDLUX-SPOT3-B-P-DALI.3h IP65	HighPower LED	225 lm / 225 lm	LiFePo4 6,4V/2,0Ah	344-B-215-04-00-00	0,8 kg

Page No.22

CENTRALTEST -ATXL ELMAX-LOOK

Type	Light Source	Light Flux / Emergency mode	Battery	Order Code	Weight
LEDLUX-SPOT3-B-P-ATXL.1h IP65	HighPower LED	225 lm / 225 lm	LiFePo4 6,4V/1,0Ah	344-B-216-04-00-00	0,7 kg
LEDLUX-SPOT3-B-P-ATXL.3h IP65	HighPower LED	225 lm / 225 lm	LiFePo4 6,4V/2,0Ah	344-B-217-04-00-00	0,8 kg

Page No.24

Wireless CENTRALTEST ELMAX-ATRF

Type	Light Source	Light Flux / Emergency	Battery	Order Code	Weight
LEDLUX-SPOT3-B-P-ATRF.1h	HighPower LED	225 lm / 225 lm	LiFePo4 6,4V/1,0Ah	344-B-218-04-00-00	0,7 kg
LEDLUX-SPOT3-B-P-ATRF.3h	HighPower LED	225 lm / 225 lm	LiFePo4 6,4V/2,0Ah	344-B-219-04-00-00	0,8 kg

CENTRAL BATTERY (CBS)

Type	Version	Light Source	Light Flux	Order Code	Weight
C.LEDLUX-SPOT3-B-P IP65 230V AC/DC	CBS NON-ADDRESSABLE	HighPower LED	225 lm	344-B-220-00-00-00	0,6 kg
C.LEDLUX-SPOT3-B-P IP65 24V AC/DC	CBS NON-ADDRESSABLE	HighPower LED	225 lm	344-B-221-00-00-00	0,6 kg

DALI CENTRAL BATTERY (CBS)

Type	Version	Light Source	Light Flux	Order Code	Weight
C.LEDLUX-SPOT3-B-P-DALI IP65 230V AC	DALI CBS	HighPower LED	225 lm	344-B-222-00-00-00	0,6 kg

Look up pages No. 190-197 for 1lx Spacing tables
 Pozri str.190-197 pre rozmiestnenie svietidiel na dosiahnutie 1lx

All LED parameters are describing the light source lm output. For the lighting calculation please use LDT file available on www.sec.sk
 LED parametre sú platné pre LED svetelné zdroje samotné. Pre svetelno-technický výpočet použite LDT súbor na www.sec.sk